

## Quick Setup Guide

### Network Video Recorder



For detailed manuals, tools, etc., please visit [foscam.com/downloads](http://foscam.com/downloads).

V1.1  
305503000894

# 1 Before You Start

## Package Contents

NVR	Ethernet Cable
DC Power Adapter	USB Mouse
Quick Setup Guide	Screw Pack
Warning Card	Data Wire and Power Wire of the Hard Drives

## Security Warning

- Foscam cameras and NVRs require good security practices to safeguard your privacy. You should regularly change your camera or NVR password which is the combination of numbers, letters and symbols.
- You should update your camera or NVR regularly. Make sure your camera or NVR has the latest firmware installed for your specific model and better experience.

-1-

# 2 Hard Disk Installation

## WARNING

- Before installing a hard disk drive (HDD), please make sure the power is disconnected from the NVR.
- It is recommended that a hard drive be used in 7200 high-speed or above.

- Remove the cover from the NVR by unfastening the screws on the rear and bottom.

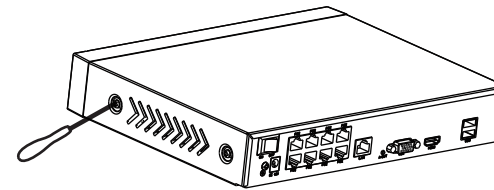

- Connect one end of the data cable and power cable to the motherboard of NVR and the other end to the HDD.

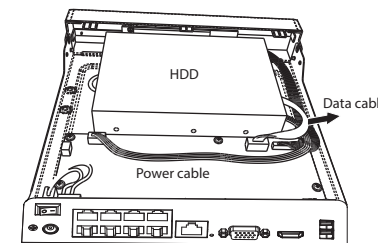

-2-

- Place the HDD on the bottom of the device and then fasten the screws on the bottom to fix the HDD.

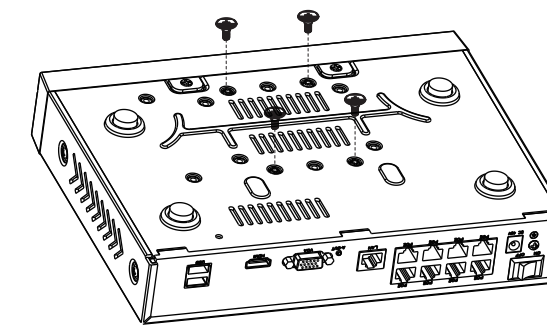

- Re-install the cover of the NVR and fasten screws.

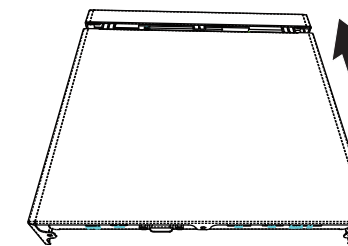

-3-

# 3 NVR Rear Panel

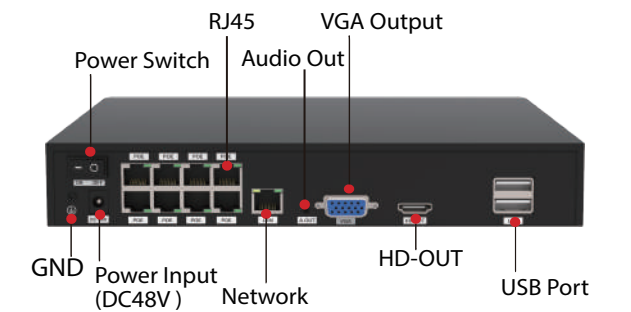
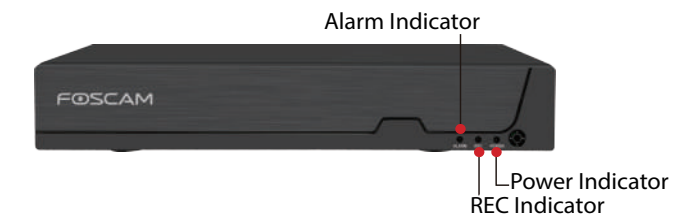

-4-

# 4 Device Connection

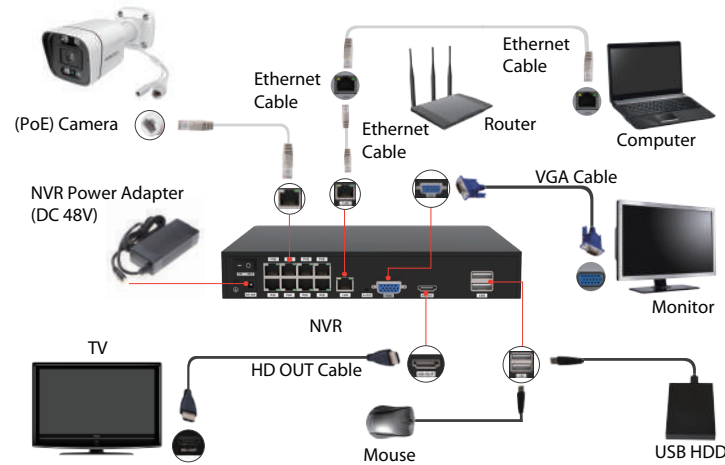

## Procedure

- If you want to use Foscam VMS or App, the NVR needs to be connected to a router. If you only use the LAN to connect to the monitor, you don't need to connect to the router.
- Connect your display to one of the video outputs (VGA or HD-OUT interface).
- Connect an external storage device to the USB interface of the NVR as a backup.
- Connect a mouse to the USB interface.
- Some devices need to connect to your router using an Ethernet cable, including the NVR, PC and IP Camera.
- Connect the power adapter to the power input port.
- The NVR DHCP server will open if it does not detect and connect a router within the 30s, which is used for searching and connecting to the IPC on the PoE NVR or switch.

-5-

If a router is connected at this time, the NVR cannot be found when adding it by APP or VMS, and the NVR needs to be restarted.  
Remarks: Users can customize the startup time or close of the NVR DHCP server.

# 5 Log In

- Turn on the power switch on the rear panel.  
After the NVR starts up successfully, the power LED and HDD LED indicators will turn green. The startup page is displayed on the screen.
- Change user name and password.  
For your security, please set a new user name and password for your NVR before Log In.

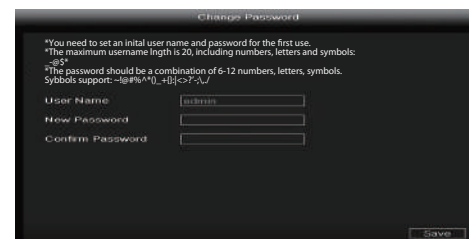

- Login page.  
Enter the Username and Password, then click on the **OK** button.

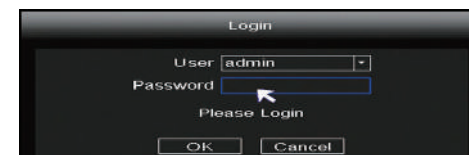

- After modifying the password, you will be taken to the **Setup Wizard**.

-6-

# 6 Setup Wizard

The Setup Wizard can walk you through some important settings on the NVR.

- Setting the time.



- Format HDD. Click the **Format** button to set up the HDD.  
Note that this will delete all files on the HDD.  
HDD Full Setting. Select Stop Record and Overwrite.

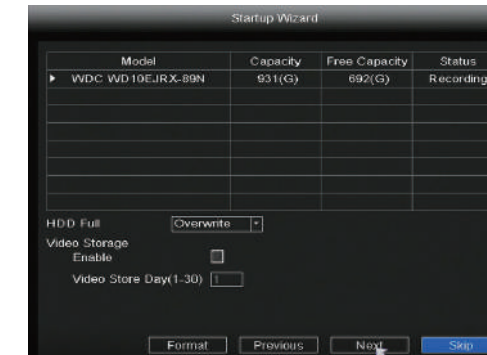

-7-

- P2P. If you want to know the UID of the device, please scan the QR code. If you don't want to use the Setup Wizard next time, uncheck the Setup Wizard checkbox. Click the **Finish** button to complete the setup wizard.



or Right-click → **Main Menu** → **Configuration** → uncheck the **Setup Wizard** checkbox. Click the **Finish** button to complete the setup wizard.

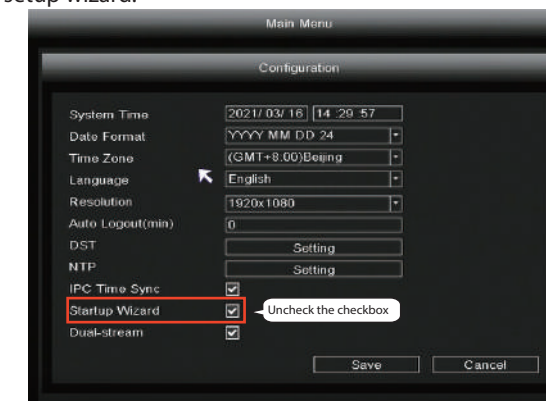

-8-

# 7 Add IP Camera

You can add an IP Camera that is connected to the internet on the NVR.

- Right-click on main interface, select **Channel Config**.
- Select **your IP Camera** or **Auto added IPC**
- Click **Add**.
- Enter username and password of the camera. If your camera is in the factory default state, you do not need to enter the user name and password.
- Click **OK**.

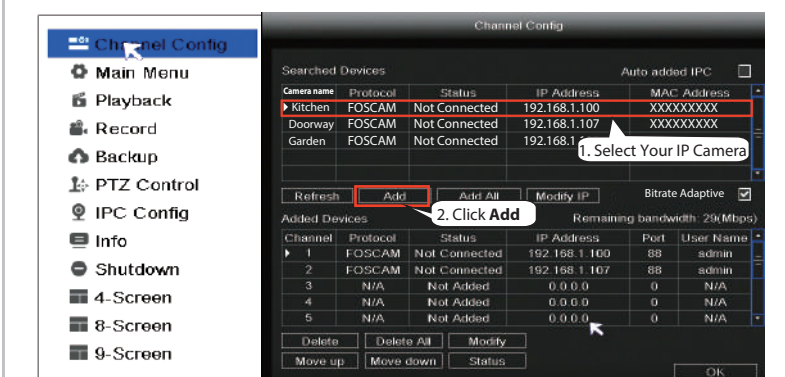

Select a protocol depending on which IP Camera you have.

- FOSCAM protocol: The High Definition (HD) IP Cameras for Foscam.
- ONVIF protocol: IP Cameras which support ONVIF protocol.

-9-



# 8 Recording

After the IP Camera is added successfully to the NVR, enable Scheduled Record functionality to the following methods when in the Live View mode.

## 8.1 Scheduled Record

Right-click → **Main Menu** → **Record** → choose recording channel → **Save** (Actually, the NVR system have default set 24h scheduled recording).

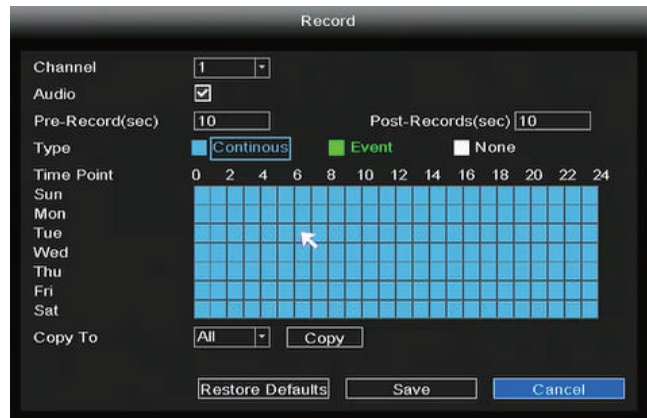

In the Live View mode, the icon is at the bottom right of the screen for each channel, indicating recording is on going.

## 8.2 Event Record

If you want to start event recording, select **Event** in Type, use the left mouse button to select the time (turned to green), if the other channels operate in the same way, select **Copy**.

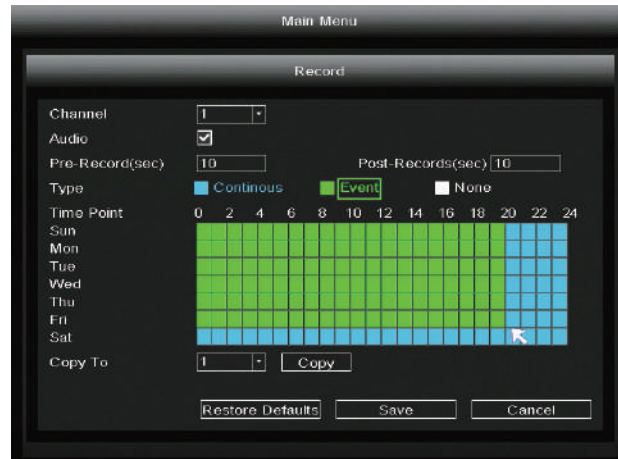

Note: The default alarm type is **Motion Detect**

In the Live View mode, the icon is at the bottom right of the screen for each channel, indicating recording is on going.

Set the event alarm according to the following method Right-click → **Main Menu** → **Event** → **Motion Detect** → choose target channel, setting Schedule, Delay, Record Channel, Tour, PTZ Activation, Send Email Buzzer → **Save**.

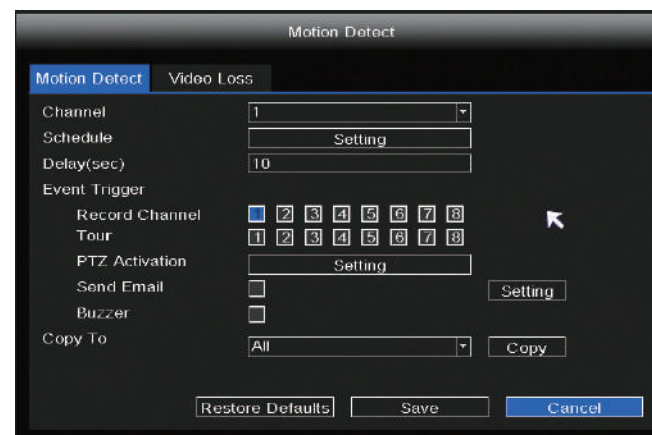

# 9 Playback

You can see the recording information, include Manual Record, Alarm Record, Schedule Record.

Right-click → **Main Menu** → **Playback** → choose channel and date → click timeline to check record.



### Note

The maximum number of 8 playback video channels have been reached, please deselect other channels first to continue.

# 10 Remote Access

You can also access the NVR or IP Camera directly through Foscam VMS and Foscam App

## 10.1 Access to the Foscam VMS

Foscam VMS is a new tool for PC. It does not require plug-ins and is compatible with Windows & Mac, It supports all Foscam HD cameras and up to 36 cameras at the same time. If you would like to manage multiple cameras, we suggest you install the Foscam VMS. You can download the "Foscam VMS" from [foscam.com/vms](http://foscam.com/vms), and can download the "Foscam VMS" Mac version from the APP store: <https://apps.apple.com/cn/app/foscamvms/id1521202507?mt=12>



**Note:** For the best experience, please update Foscam VMS to the latest version!

### Add the NVR

1. Run Foscam VMS, then you can create a local administrator account and login.
2. Tap the "+" button on the Foscam VMS and follow the setup wizard to add your NVR. Please refer to the user manual for more detailed adding steps.

3. Preview: click device in Lan Device list to enter preview interface, select a channel to view it's picture, click to enter, as follow shows:

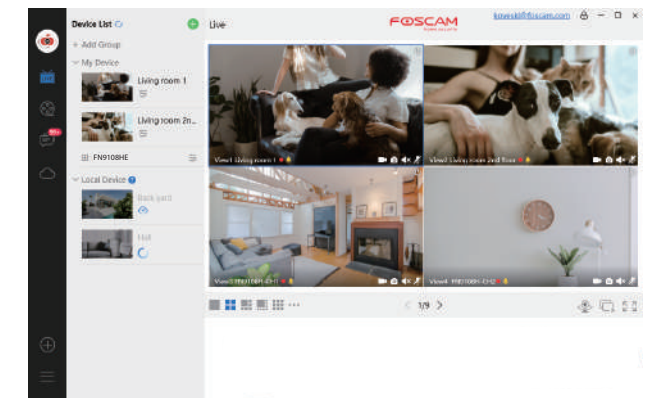

## 10.2 Access to the Foscam App

1. You can also simply go to the App Store or Google Play and search for the term "**Foscam**". Download the APP to your smartphone, or scan the QR Code on the below, it will take you to the download page to install the **Foscam APP**.



2. Run the Foscam APP, and then register for a Foscam account.
3. Device Adding: Once logged in, you can tap the "+" button on the APP, after that scan the QR code, which is located at the bottom of your NVR.
4. Preview: click device in list to enter preview interface, select a channel to view it's picture, as follow shows:

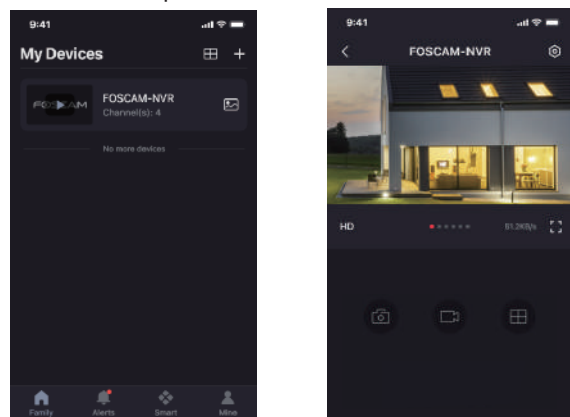

**Note:** The Foscam app is subject to the latest version, and its functions are constantly iterated.

# 11 Upgrade

1. You can upgrade your NVR and cameras system with local Software.

### NVR Upgrade:

Download the firmware to the U disk → Insert U disk to NVR USB port → Right-click → **Main Menu** → **Upgrade** → click **Refresh** → click **Upgrade** to upgrade your NVR.

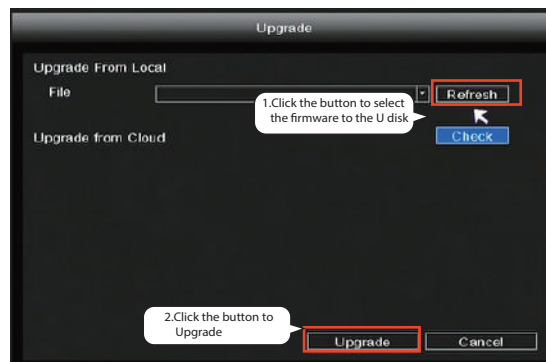

### Note:

Don't shut down the power during upgrade. After upgrading, NVR restarts.

2. You can upgrade the firmware of your NVR with Foscam VMS. Open and Login Foscam VMS, select **Setup > System > System Upgrade**.

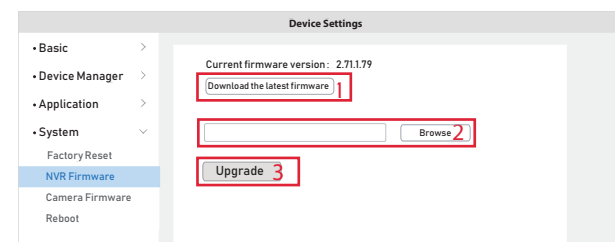

### Firmware upgrade step:

- ① Click "**Download the latest firmware**" button to download the latest firmware to your computer.
- ② Click "**Browse**" button, choose file firmware version you want to upgrade on the web page.
- ③ Click "**Upgrade**" button and wait till it's finished.

3. You can upgrade the firmware of your NVR and cameras with Foscam App.

Open Foscam APP and Login the NVR, select Settings > **NVR Firmware Upgrade**.

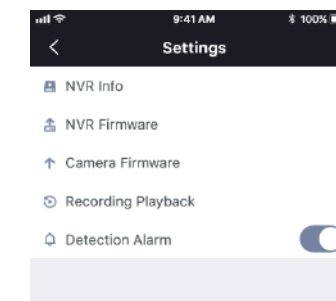

### Note:

In all upgrade methods, don't shut down the power during upgrade. After upgrading, NVR restarts.

# 12 Product Performance

Power Supply: DC 48V 2.0A 96W

# 13 Technical Support

If you have problems with your Foscam device, please contact the reseller you purchased from, or you can e-mail the headquarters technical support team: [support@foscam.com](mailto:support@foscam.com)  
Your valuable comments and suggestions on improving Foscam products are welcomed!



CE Certificate statement Website:  
<https://www.foscam.com/company/ce-certificate.html>

Exporter and Importer Information Opened to Public:  
<https://www.foscam.com/company/open-information.html>

Manufacturer: Shenzhen Foscam Intelligent Technology Co., Ltd  
Addr: Room 901-902, Building 1B, Shenzhen International Innovation Valley, Xingke 1st Street, Nanshan District, Shenzhen, Guangdong, China, 518055

[www.foscam.com](http://www.foscam.com)

Due to product upgrades and other reasons, this guide may be slow to update, resulting in slight inconsistencies with the official website information. Please take the official website ([www.foscam.com](http://www.foscam.com)) information as the current standard.