

User Manual

QHD WiFi IP Camera



Model: V5P

Table of Contents

| | |
|--|---|
| 1 Overview..... | 3 |
| 1.1 Key Features..... | 3 |
| 1.2 Read before Use..... | 3 |
| 1.3 Packing Contents..... | 3 |
| 1.4 Physical Description..... | 4 |
| 1.5 SD Card Management..... | 5 |
| 1.6 Add Device: Connection via the Foscam App..... | 5 |
| 1.7 Installation..... | 5 |
| 1.8 Waterproof Lid Installation Guide..... | 5 |
| 2 Default Parameters..... | 6 |
| 3 Specification..... | 7 |

1 Overview

1.1 Key Features

- ◆ 5MP QHD Waterproof IP Camera
- ◆ H.264+/H.264 video Compression
- ◆ Supports Human detection, Motion Detection and Vehicle Detection
- ◆ Compatible with free Foscam Video Management Software
- ◆ Compatible with free Foscam iOS and Android APP
- ◆ Support 2.4GHz&5GHz dual-band WiFi
- ◆ Supports Full Duplex two-way Audio
- ◆ Supports WDR(Wide-Dynamic Range)
- ◆ Supports 256GB Micro SD Card storage(External)
- ◆ Night Vision Range up to 20m(66 feet)
- ◆ P2P Feature for Easy Remote Access
- ◆ Supports image snapshot
- ◆ Supports dual-stream
- ◆ Supports remote viewing & record from anywhere anytime
- ◆ Multi-level users management with password protection
- ◆ Supports multiple network protocols: IP, TCP, UDP, SMTP, FTP, DHCP, RTSP
- ◆ Supports Alexa
- ◆ Supports Google home

1.2 Read before Use

Please first verify that all contents received are complete according to the Package Contents listed below. Before the Network Camera is installed, please carefully read and follow the instructions in the Quick Setup Guide to avoid damage due to faulty assembly and installation. This also ensures the product is used properly as intended.

1.3 Packing Contents

| | |
|-------------------------|------------------------|
| ● Camera× 1 | ● Ethernet Cable× 1 |
| ● Quick Setup Guide × 1 | ● Expansion Screws× 1 |
| ● Waterproof Lid × 1 | ● Mounting Template× 1 |
| ● Power Adapter × 1 | ● Wi-Fi Antenna× 1 |

1.4 Physical Description

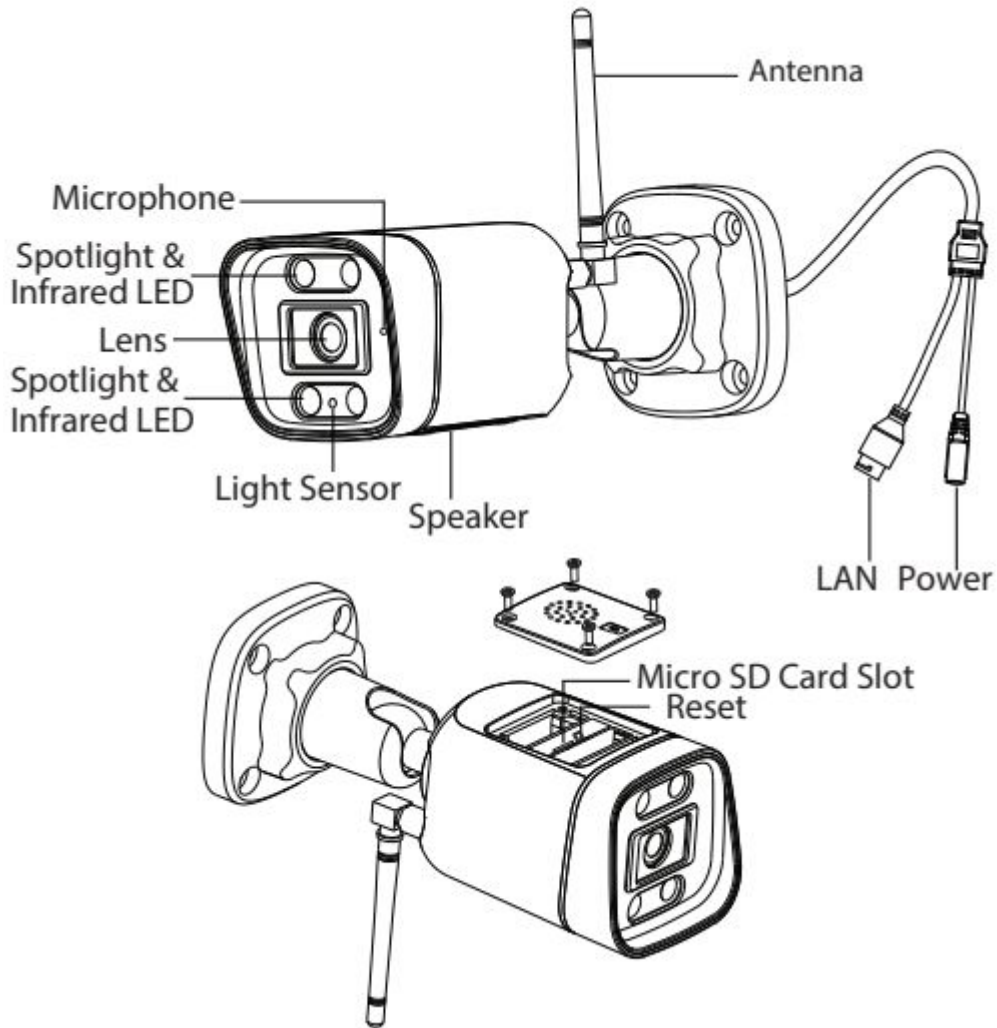

Microphone: Built-in Microphone.

Lens: Fixed focus lens.

Spotlight: See full-color images at night with the spotlight on.

LED Indicator: Infrared LED for night vision.

Reset: Press and hold on the reset button for 3~5 seconds. Releasing the reset button, the password will back to the factory default administrator password.

Micro SD Card slot: Supports up to 256GB SD card for storing the video.

Speaker: Built-in speaker

Power: AC wiring interface.

LAN:10/100M adaptive Ethernet interface. Through this interface, IP camera can be connected with various network devices, such as hub, router, etc.

1.5 SD Card Management

This camera supports Micro SD Card.

When you plug in the SD card during the camera work process, please reboot the camera again, or else the SD card might not work well.

On Foscam app go to the **Settings**→**Device Status**→**Device Status** page, you can see the SD card status.

1.6 Add Device: Connection via the Foscam App

Scan the QR code below to download and install the Foscam APP.



Please refer to the **Quick Setup Guide**.

1.7 Installation

Please refer to the **Quick Setup Guide**.

Point the camera at the desired location and use the screws provided to mount it.

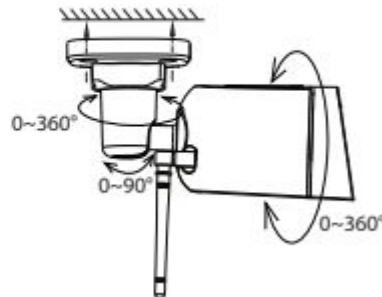
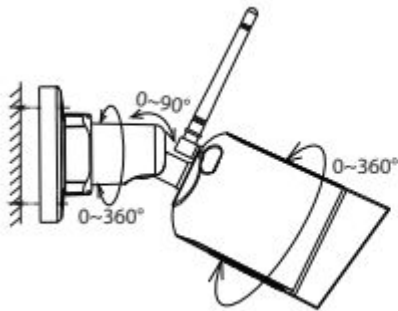

Please Note:

Ensure that rain or water will not reach the connector ports at the end of the pig tail wiring. These connectors are not weather-resistant.

1.8 Waterproof Lid Installation Guide

When mounting your camera outdoors, you are suggested to install the waterproof lid for it. You may follow the steps for installation.

1. Thread the Ethernet cable through the top cover and then the waterproof connector.

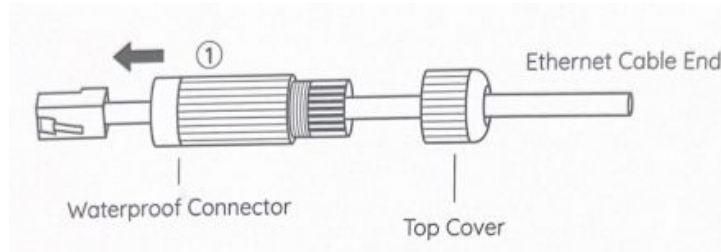

2. Put the rubber seal ring around the Ethernet cable between the top cover and the waterproof connector.

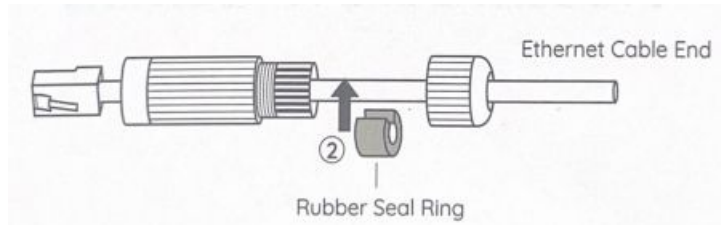

Note: The rubber seal ring provided has been cut. If not, you may manually cut it.

3. Put on the rubber O-ring to the Ethernet port of the camera and plug the Ethernet cable into the Ethernet port.

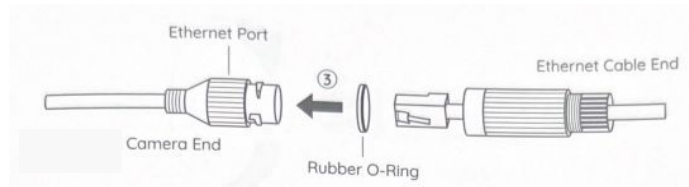

4. Align the waterproof connector with the Ethernet port, then twist it clockwise to tighten the two parts.

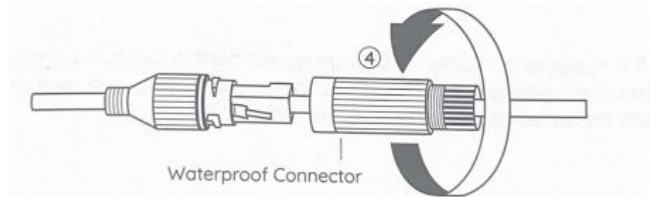

5. Push the rubber seal ring into the waterproof connector, then screw the top cover and lock it into position firmly to finish installation.

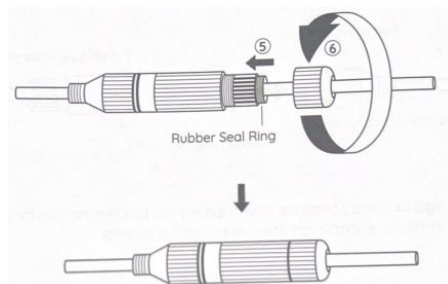

2 Default Parameters

Default network parameters

IP address: obtain dynamically

Subnet mask: obtain dynamically

Gateway: obtain dynamically

3 Specification

| | ITEMS | V5P |
|----------------------------|-------------------------|--|
| Spotlight | Color Temperature | 4500K |
| Image Sensor | Sensor Type | High Definition Color CMOS Sensor |
| | Display Resolution | 5.0Megapixels(3072*1728) |
| | Min. Illumination | 0 Lux (With IR Illuminator) |
| Lens | Lens Type | f:4mm; F2.1 |
| | Angle of view | Diagonal: 107.9°, Horizontal: 91.6°, Vertical: 49.6° |
| Video | Image Compression | H.264+/H.264 |
| | Image Frame Rate | Max 25fps (5MP), downward adjustable |
| | Resolution | 5MP(3072*1728) 1.5M/25 fps, 1080P(1920*1080)1M/25fps, 720P(1280*720)1M/15fps |
| | Stream | Dual stream |
| | Image Adjustment | The hue, brightness, contrast, saturation, sharpness are adjustable |
| | Flip Image | Flip and mirror |
| | Night Mode | Manual and automatic modes, when the white light is on, the night vision image is colored |
| | Night Visibility | 20m |
| Audio | Input/Output | Built-in mic and speaker, supports full duplex 2-way Audio |
| | Audio Compression | PCM/AAC |
| | Siren | Support maximum 100dB alarm siren |
| Network | Ethernet | One 10/100Mbps RJ45 port |
| | Wireless Standard | IEEE802.11b/g/n/ac |
| | Wireless Security | WPA, WPA2 |
| | Remote Access | P2P |
| | Wifi configuration Mode | Support scan QR code, sound wave to add camera |
| | Network Protocol | IP, TCP, UDP, SMTP, FTP, RTSP |
| System Requirements | Operating System | Microsoft Windows (Foscam VMS), MacOS (Foscam VMS), Android (Foscam app), iOS (Foscam app) |
| Other Features | Light Control | Manual switch or alarm linkage |
| | Motion Detection | Alarm via E-Mail, FTP and Foscam app when an event is detected |
| | Vehicle Detection | Alarm via E-Mail, FTP and Foscam app when an event is detected |
| | Human Detection | Alarm via E-Mail, FTP and Foscam app when an event is detected |
| | User Accounts | Three levels user role |
| | Privacy Block | Yes |
| | WDR | Improve image clarity in complex scenario |
| | Zoom | 6X digital zoom function |
| | Storage | Support max. 256GB Micro SD card, local and FTP storage, Foscam cloud storage |

| | | |
|----------------------|-----------------------|-------------------------------|
| | Intelligent Assistant | Works with Alexa, Google Home |
| Power | Power Supply | DC12V/1A |
| | Power Consumption | 5Watts (Max.) |
| Physical | Dimension(LxWxH) | 170(L)x66 (W)x66 (H) |
| | Net Weight | 346g |
| Environment | Waterproof | IP66 |
| | Operating Temperature | -20°C~ 50°C (-4°F ~ 122°F) |
| | Operating Humidity | 20% ~ 85% non-condensing |
| | Storage Temperature | -20°C ~ 60°C (-4°F ~ 140°F) |
| | Storage Humidity | 0% ~ 90% non-condensing |
| Certification | CE, FCC, RoHS,WEEE | |

For other parts, please refer to the “FOSCAM Camera User Manual”